

TNC REVERSE POLARITY
RF COAXIAL CONNECTORS



Key performance

- Characteristic Impedance : 50 Ω
- Frequency range : 0~11GHz
- Center resistance :
 - Center conductor ≤2.0m Ω
 - Out conductor ≤0.2m Ω
- Insulation resistance : ≥ 5000M Ω
- Insulator voltage withstanding : 1500V
- VSWR : ≤1.30
- Connector durability : 500 cycles

Executive standard : MIL-C-39012

Material

- Center contacts:
 - Male---brass, gold plated.
 - Female---phosphor bronze, gold plated
- Bodies and other metal parts:
 - brass, nickel plated
- Insulators: TFE
- Crimp ferrule: copper, nickel plated.
- Gasket and seal rings: silicone rubber
- Heat-shrink tubing: thermofit plastic.

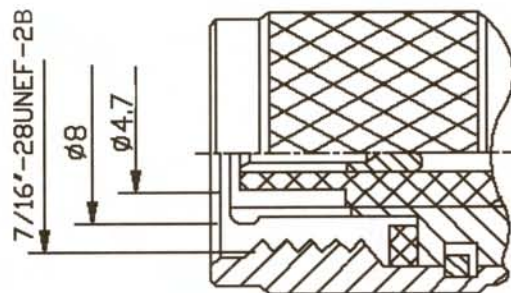
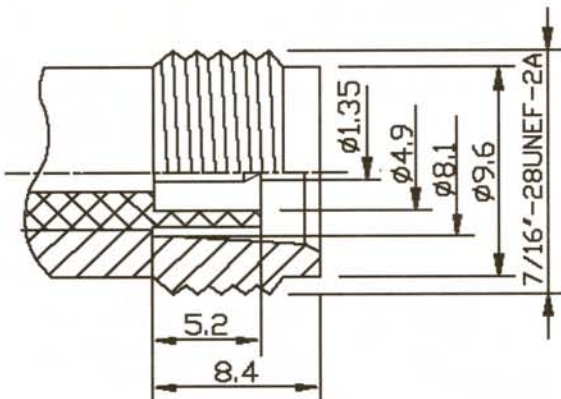

TNC-FKB2 ...

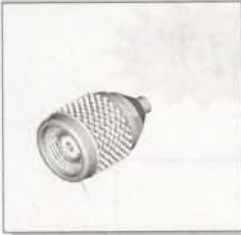

Type	Cable code	D
TNC-FKB2	B2	Φ2.2
TNC-FKB3	B3	Φ3.6

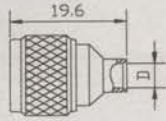

TNC-FJB2 ...



Type	Cable code	D
TNC-FJB2	B2	Φ2.2
TNC-FJB3	B3	Φ3.6

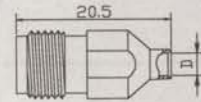

TNC-FJFB2 ...



Type	Cable code	D
TNC-FJFB2	B2	Φ2.2
TNC-FJFB3	B3	Φ3.6

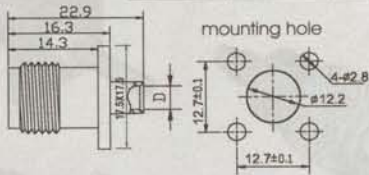

TNC-FK3Y ...



Type	Cable type
TNC-FK3Y	3
TNC-FK5Y	5

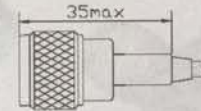

TNC-FJF3 ...



Type	Cable type	D
TNC-FJF3	3	Φ3.0
TNC-FJF5	5	Φ5.3

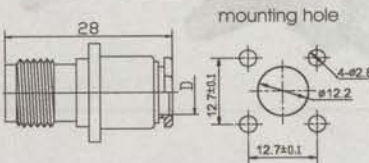

TNC-FKW3Y ...



Type	Cable type
TNC-FKW3Y	3
TNC-FKW5Y	5

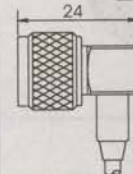

TNC-FJW3Y ...



Type	Cable type
TNC-FJW3Y	3
TNC-FJW5Y	5

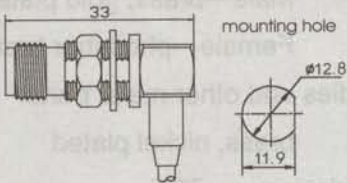

TNC-FKFD

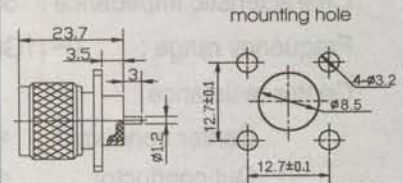

TNC-FKK

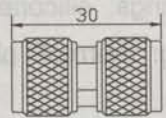

TNC-FJFD

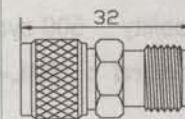

TNC-FJFJ

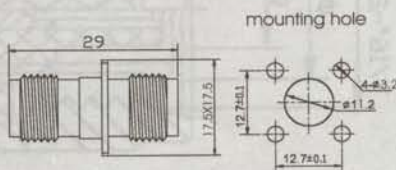

TNC-FJKJ

