

SMA REVERSE POLARITY
RF COAXIAL CONNECTORS



Key performance

- Characteristic Impedance : 50 Ω
- Frequency range :
 - With flexible cable: 0~12.4GHz
 - With semi-rigid/comfortable cable:0-18GHz
- Contact resistance :
 - Center conductor ≤ 3.0m Ω
 - Out conductor ≤ 2.0m Ω
- Insulation resistance : ≥ 5000M Ω
- Insulator voltage withstanding : 1000V
- VSWR : with fiexiable cable:
 - ≤ 1.15+0.02f
 - with semi-rigid/flexiabile cable:
 - ≤ 1.10+0.01f
- Connector durability : 500 cycles
- Applicable spec/std:** MIL-C-39012

Material

- Center contacts:
 - Male---brass, gold plated.
 - Female---beryllium copper, gold plated
- Bodies and other metal parts:
 - brass, gold plated
- Insulators: TFE
- Crimp ferrule: copper, nickel plated.
- Gasket and seal rings: silicone rubber
- Heat-shrink tubing: thermofit plastic.

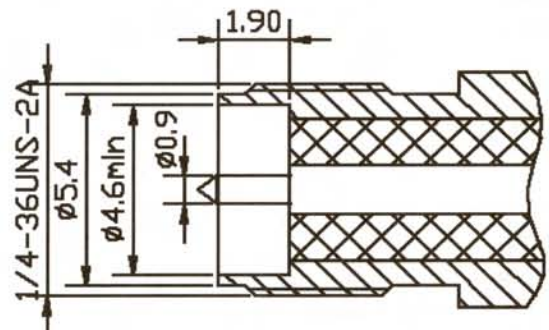
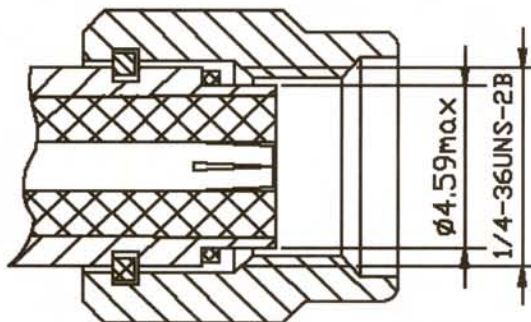

SMA-FKB2 SMA-FKB3

Type	Cable code	D	d
SMA-FKB2	B2	Φ 3.0	Φ 2.2
SMA-FKB3	B3	Φ 4.6	Φ 3.6

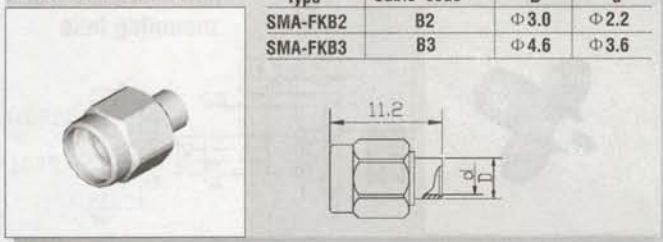

SMA-FJB2 SMA-FJB3

Type	Cable code	d
SMA-FJB2	B2	Φ 2.2
SMA-FJB3	B3	Φ 3.6

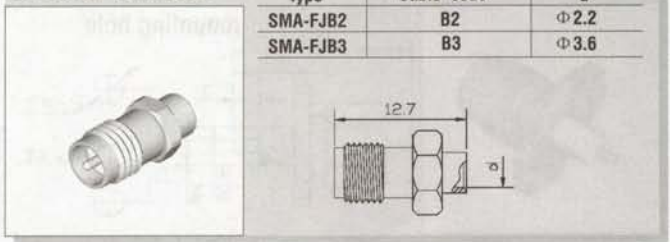

SMA-FKB3B

Type	Cable code
SMA-FKB3B	B3

Without contact

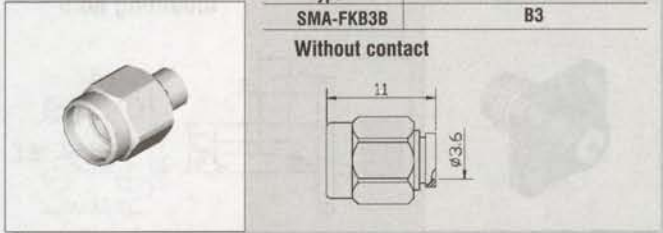

SMA-FJFB2 SMA-FJFB3

Type	Cable code	L	d
SMA-FJFB2	B2	12.7	Φ 2.2
SMA-FJFB3	B3	13.6	Φ 3.6

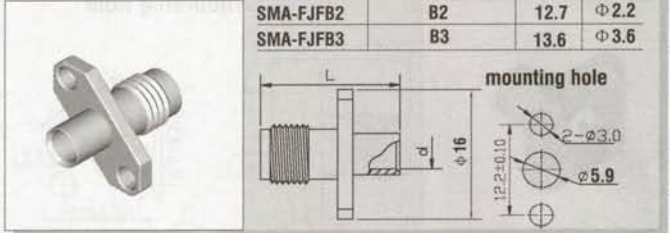

SMA-FKWB2 SMA-FKWB3

Type	Cable code	d
SMA-FKWB2	B2	Φ 2.2
SMA-FKWB3	B3	Φ 3.6

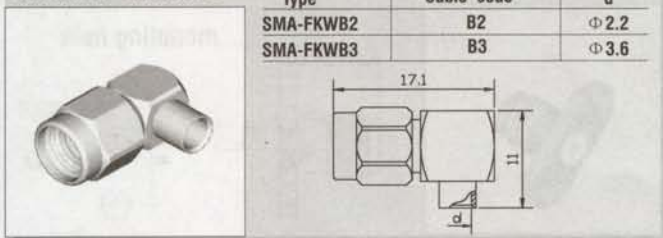

SMA-FJYB2 SMA-FJYB3

Type	Cable code	L	d
SMA-FJYB2	B2	16	Φ 2.2
SMA-FJYB3	B3	17	Φ 3.6

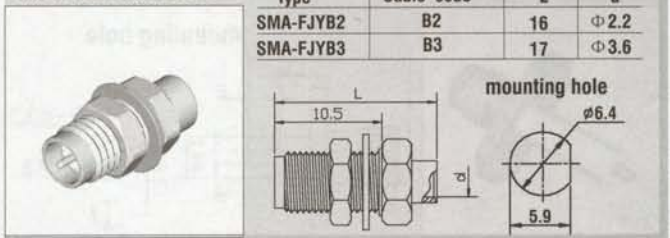

SMA-FK3...

Type	Cable code	L
SMA-FK3	3	17.5
SMA-FK5	5	23.5

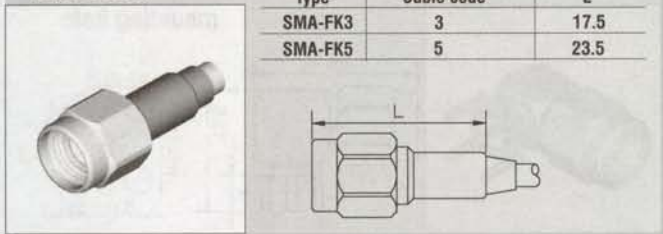

SMA-FJWY3...

Type	Cable code
SMA-FJWY3	3
SMA-FJWY5	5

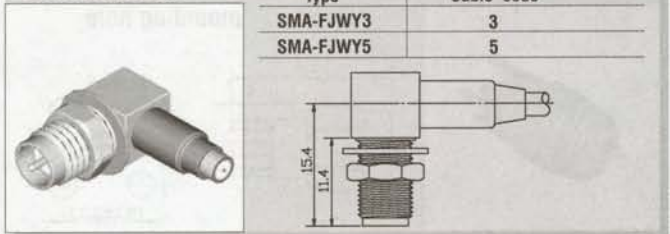

SMA-FKW3...

Type	Cable code	L
SMA-FKW3	3	13.0
SMA-FKW5	5	18.0

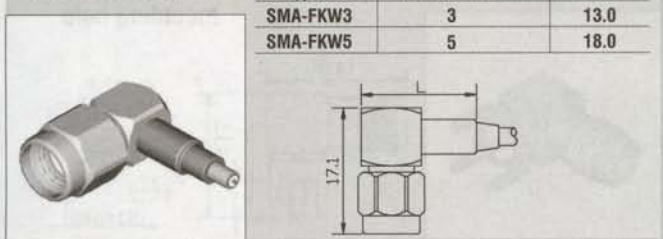

SMA-FJ3...

Type	Cable code	L
SMA-FJ3	3	17.0
SMA-FJ5	5	22.0

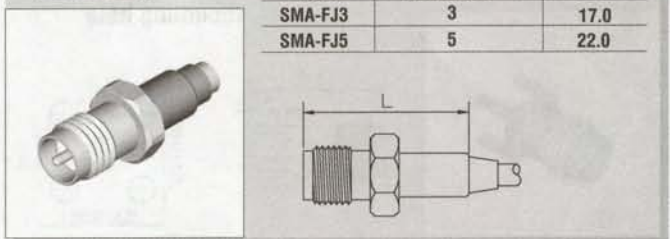

SMA-FJF3...

Type	Cable code	L
SMA-FJF3	3	17.0
SMA-FJF5	5	22.0

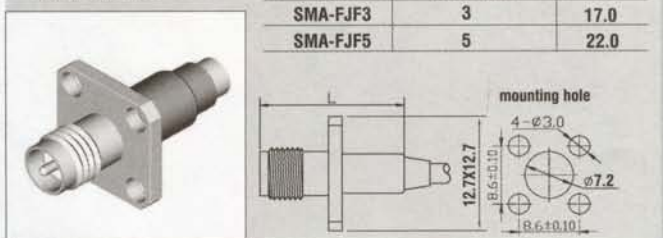

SMA-FJY3...

Type	Cable code	L
SMA-FJY3	3	18.8
SMA-FJY5	5	23.2

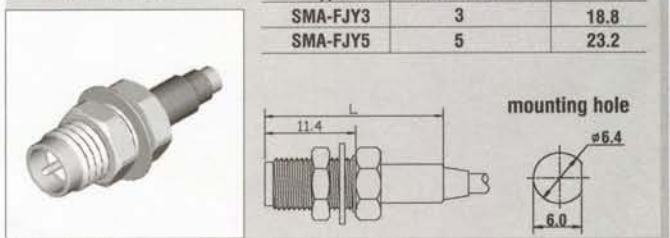

SMA-FKFD28

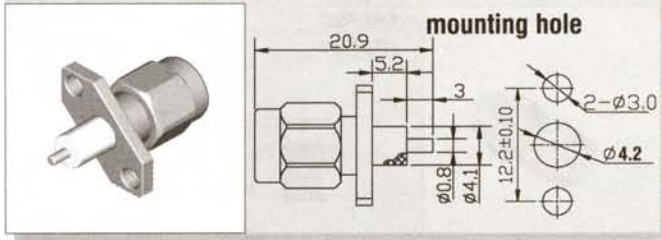

SMA-FJFD24

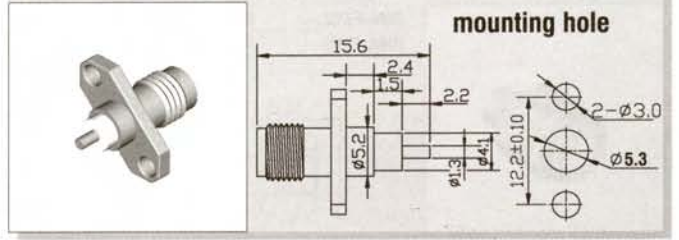

SMA-FJFD48...

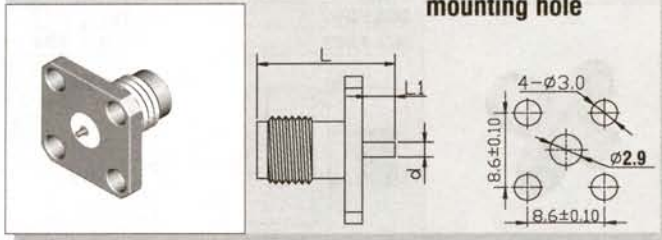

SMA-FJFD19...

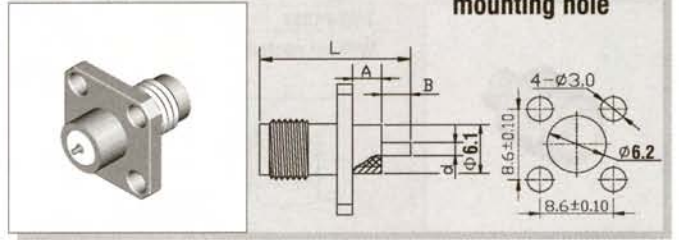

SMA-FJFD3...

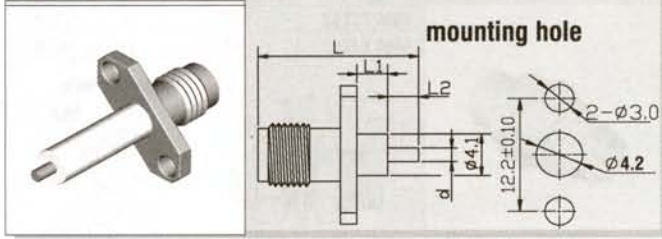

SMA-FJFD71...

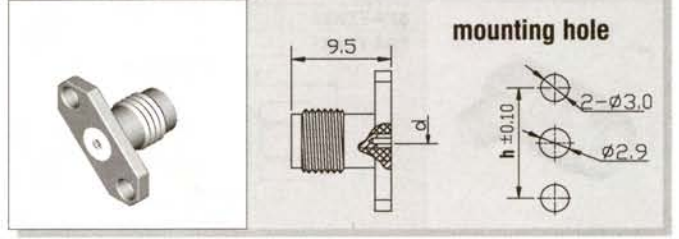

SMA-FKHD

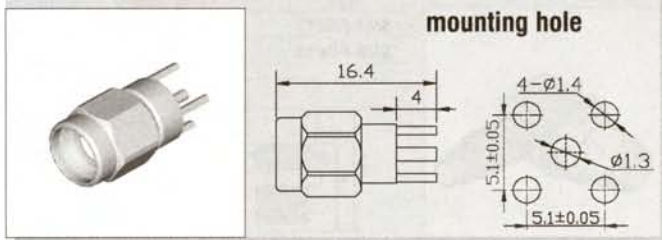

SMA-FKWHD

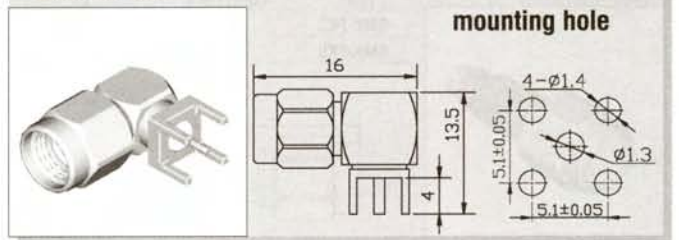

SMA-FJHD

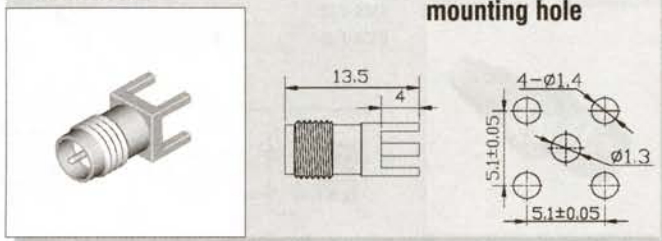

SMA-FJWHD

