

SERIES SMZ-75 RF COAXIAL CONNECTORS

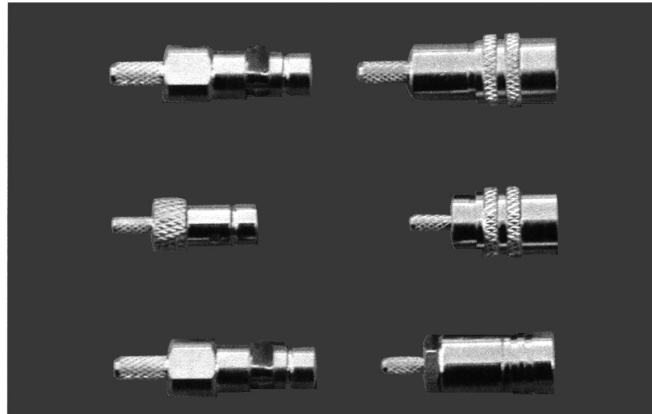

Series SMZ-75 is push-pull self-latching style RF coaxial connector. It is convenience and reliable connection, mainly and widely used in communication device.

Key performance

Characteristic Impedance : 75 Ω

Frequency range : 0~1GHz

Contact resistance :

Center conductor ≤ 6.0m Ω

Out conductor ≤ 2.0m Ω

Insulation resistance : ≥ 1000M Ω

Insulator voltage withstanding : 750V

Connector durability : 500 cycles

Applicable spec/std : BS 9210

Material

Center contacts:

Male---brass, gold plated.

Female---phosphor bronze, gold plated

Bodies and other metal parts:

brass, gold or nickel plated

Insulators: Teflon

Crimp ferrule: copper, nickel plated.

Gasket and seal rings: silicone rubber

Heat-shrink tubing: thermofit plastic.

Interface Dimensions

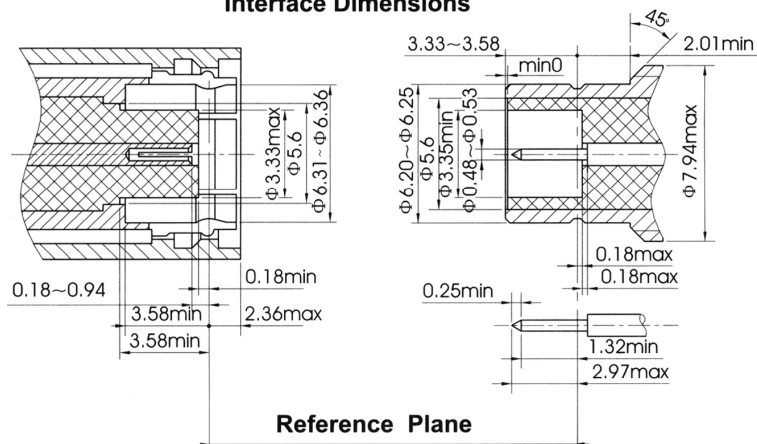

SMZ-75 SERIES

CERNEX, Inc.

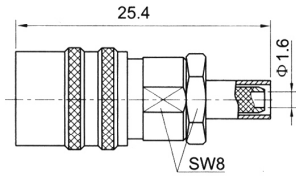

Type	part number	suitable cable	Note
SMZ-75K3A	2121-6501	3	

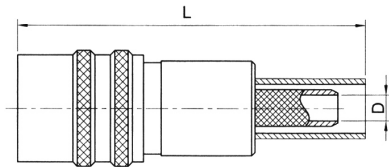

Type	part number	suitable cable	L	D	Note
SMZ-75K4	2121-6502	4	30	$\Phi 2.1$	
SMZ-75K4A	2121-6503	4	32.7	$\Phi 2.5$	

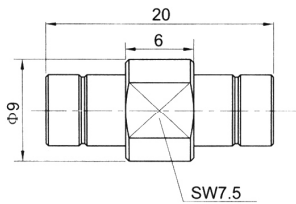

Type	part number	Note
SMZ-75JJ	2100-6901	

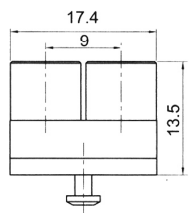

Type	part number	Note
SMZ-75KWWK	2101-6902	

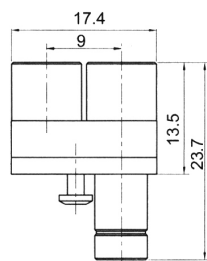

Type	part number	Note
SMZ-75KJKR	2101-6901	